

# Tub & Shower Fittings

## SH-PB1-00-031

### Product Type

---

Pressure balancing tub and shower system with hand spray and 24" slide bar

### Features & Specifications

---

- 1.5 GPM hand spray with 59" stainless steel hose and pause control
- 24" wall-mounted slide bar with hand spray holder
- Pressure balancing valve cartridge

### Performance Specification

---

- Rated Operating Pressure: 20-125 PSI
- Rated Operating Temperature: 40-140°F



### Warranty

---

- 5-Year Limited Cartridge Warranty
- Lifetime Limited Faucet Warranty
- 1-Year Limited Finish Warranty

### Codes & Standards

---

-  ASME A112.18.1/CSA B125.1
-  ADA ANSI/ICC A117.1
- Complies with ASSE 1016/ASME A112.1016/CSA B125.16
- 

Job Name \_\_\_\_\_

Item Number \_\_\_\_\_

Section/Tag \_\_\_\_\_

Model Specified \_\_\_\_\_

Architect \_\_\_\_\_

Engineer \_\_\_\_\_

Contractor \_\_\_\_\_

Submitted as Shown       Submitted with Variations

Date \_\_\_\_\_



## Architect/Engineer Specification

Chicago Faucets No. SH-PB1-00-031, Tub and Shower System with pressure balancing valve, wall-mounted. Chrome plated. Includes pressure balancing cartridge. 1/2" nominal copper and 1/2" NPT hot and cold supply inlets and outlets. Shower valve cycles from cold to hot. Wall plate includes embossed and color-coded temperature index. Integral service stops with checks to prevent cross-flow. Includes wall elbow and in-line vacuum breaker. 1.5 GPM hand spray with 59" stainless steel hose and pause control. 24" wall-mounted slide bar with hand spray holder. This product meets ADA ANSI/ICC A117.1 requirements and is tested and certified to industry standards: ASME A112.18.1/CSA B125.1, and ASSE 1016.

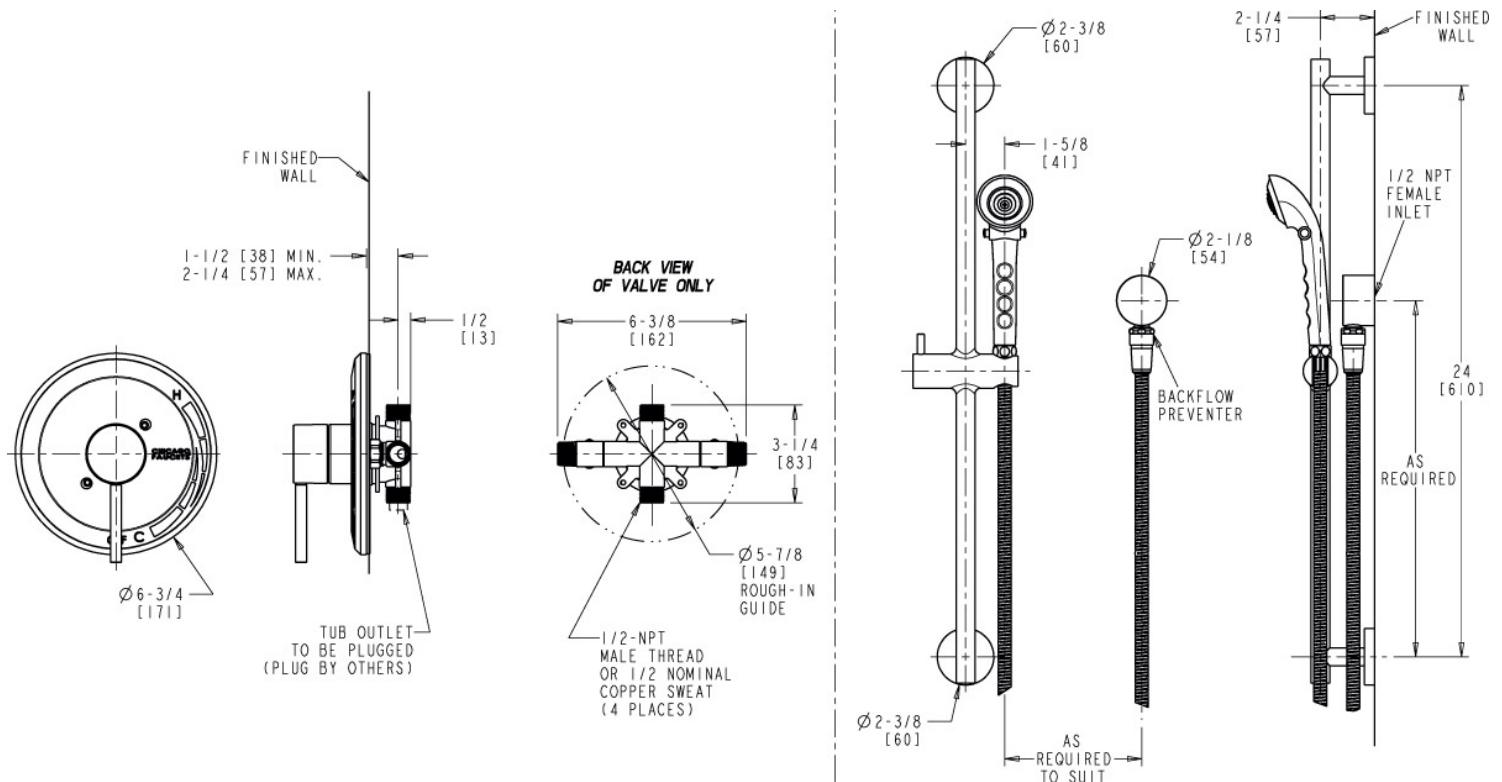

## Operation and Maintenance

Installation should be in accordance with local plumbing codes. Flush all pipes thoroughly before installation. After installation, remove spout outlet or flow control and flush faucet thoroughly to clear any debris. Care should be taken when cleaning the product. Do not use abrasive cleaners, chemicals or solvents as they can result in surface damage. Use mild soap and warm water for cleaning and protecting the life of Chicago Faucet products. For specific operation and maintenance refer to the installation instructions and repair parts documents that are located at [www.chicagofaucets.com](http://www.chicagofaucets.com).

Chicago Faucets, member of the Geberit Group, is the leading brand of commercial faucets and fittings in the United States, offering a complete range of products for schools, laboratories, hospitals, office buildings, food service, airports and sport facilities. Call 1.800.TECTRUE or 1.847.803.5000 Option 1 for installation or other technical assistance.

