

# L Series Lab Fittings

## LWV2-A11-10

### Product Type

---

Deck-mounted laboratory turret with water valve

### Features & Specifications

---

- Laboratory nozzle with 10 serrations for laboratory hose
- Vandal Proof 2-1/2" cross handle with button indexed 'CW'
- Slow compression operating cartridge, left-hand

### Performance Specification

---

- Rated Operating Pressure: 20-125 PSI max.
- Rated Operating Temperature: 40-140°F

### Warranty

---

- 5-Year Limited Faucet Warranty
- Lifetime Limited Faucet Warranty
- 1-Year Limited Finish Warranty
- 5-Year Limited Mechanical Warranty

### Codes & Standards

---

-  ASME A112.18.1/CSA B125.1

Job Name \_\_\_\_\_

Item Number \_\_\_\_\_

Section/Tag \_\_\_\_\_

Model Specified \_\_\_\_\_

Architect \_\_\_\_\_

Engineer \_\_\_\_\_

Contractor \_\_\_\_\_

Submitted as Shown       Submitted with Variations

Date \_\_\_\_\_



**Architect/Engineer Specification**

Chicago Faucets No. LWV2-A11-10 Deck-mounted laboratory turret with water valve, polished chrome finish. Laboratory nozzle with 10 serrations for laboratory hose. Slow compression operating cartridge, left-hand turn. 2-1/2" cross handle with button indexed 'CW'.

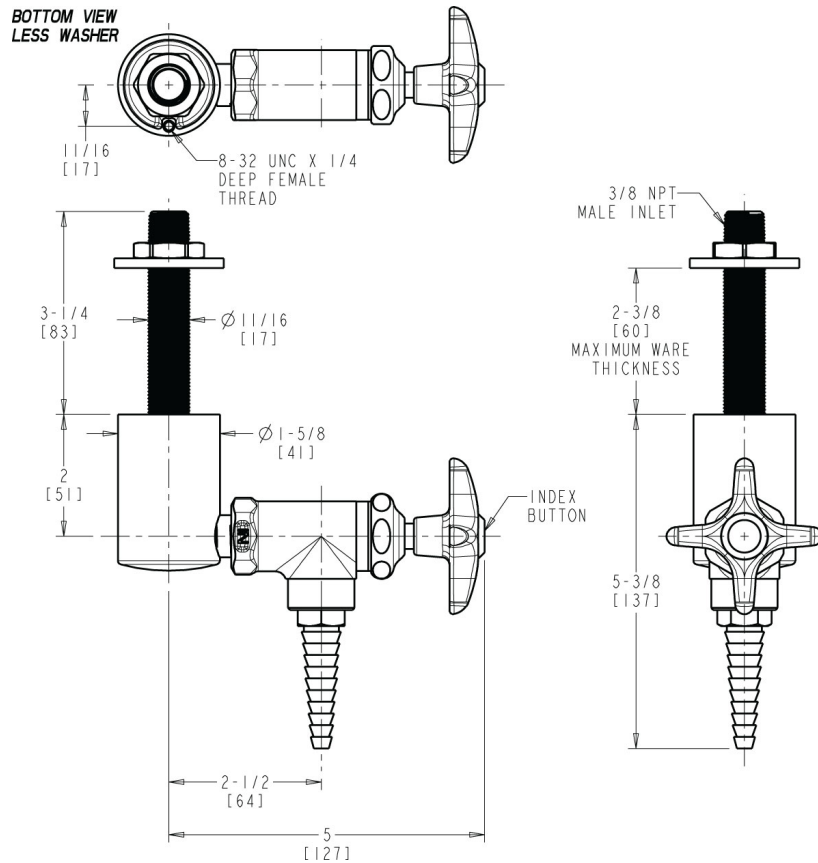

**Operation and Maintenance**

Installation should be in accordance with local plumbing codes. Flush all pipes thoroughly before installation. After installation, remove spout outlet or flow control and flush faucet thoroughly to clear any debris. Care should be taken when cleaning the product. Do not use abrasive cleaners, chemicals or solvents as they can result in surface damage. Use mild soap and warm water for cleaning and protecting the life of Chicago Faucet products. For specific operation and maintenance refer to the installation instructions and repair parts documents that are located at [www.chicagofaucets.com](http://www.chicagofaucets.com).

Chicago Faucets, member of the Geberit Group, is the leading brand of commercial faucets and fittings in the United States, offering a complete range of products for schools, laboratories, hospitals, office buildings, food service, airports and sport facilities. Call 1.800.TECTRUE or 1.847.803.5000 Option 1 for installation or other technical assistance.

