

# L Series Lab Fittings

## LEF-A21-10T

### Product Type

---

Touchless electronic faucet

### Features & Specifications

---

- Single-hole
- 5-1/4" rigid/swing gooseneck spout
- Laboratory nozzle with 10 serrations for laboratory hose
- HyTronic® module kit with Bluetooth® communication
- ECAST® design provides durable cast brass construction with total lead content equal to or less than 0.25% by weighted average
- Complies with the requirements of the Buy American Act of 1933.

### Performance Specification

---

- Rated Operating Pressure: 20-125 PSI max.
- Rated Operating Temperature: 40-140°F

### Warranty

---

- 5-Year Limited Faucet Warranty
- Lifetime Limited Faucet Warranty
- 1-Year Limited Finish Warranty
- 5-Year Limited Mechanical Warranty

### Codes & Standards

---

-  ASME A112.18.1/CSA B125.1

Job Name \_\_\_\_\_

Item Number \_\_\_\_\_

Section/Tag \_\_\_\_\_

Model Specified \_\_\_\_\_

Architect \_\_\_\_\_

Engineer \_\_\_\_\_

Contractor \_\_\_\_\_

Submitted as Shown       Submitted with Variations

Date \_\_\_\_\_



### ECAST

ECAST products are intended for installation where state laws and local codes mandate lead content levels or in any location where lead content is a concern.

## Architect/Engineer Specification

Chicago Faucets No. LEF-A21-10T Touchless electronic sink faucet, polished chrome finish. Single-hole mount. 5-1/4" rigid/swing gooseneck spout. Laboratory nozzle with 10 serrations for laboratory hose. AC operation, includes plug-in, single-use Class 2A transformer. Built-in Bluetooth® technology allows for easy adjustments and mode changes using a smartphone or tablet with the Chicago Faucets CF Connect App.

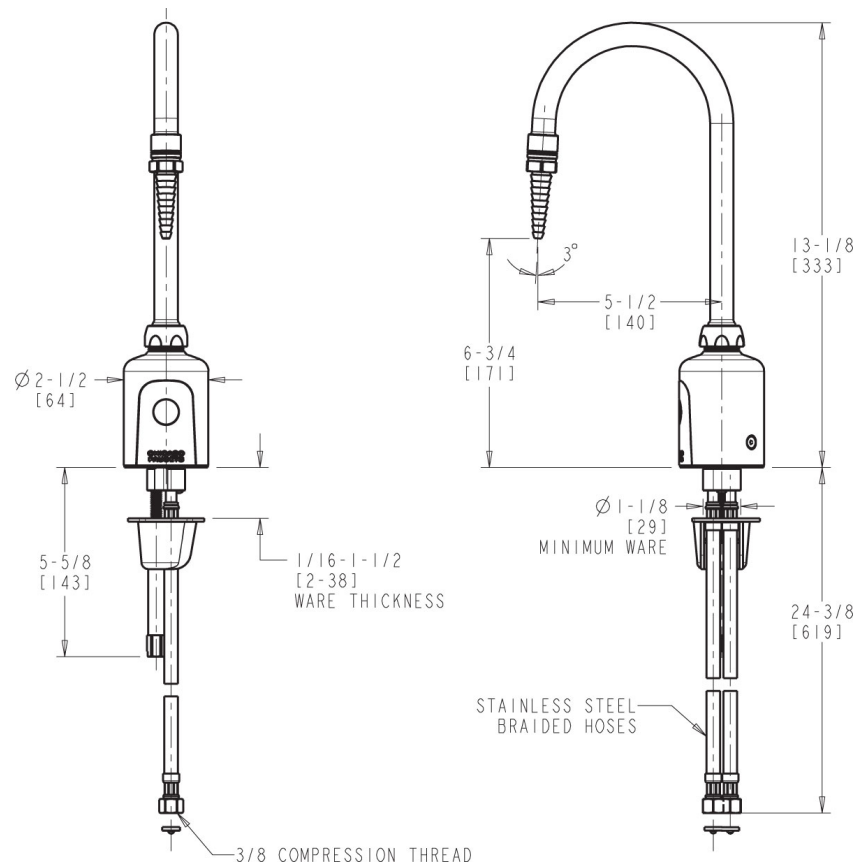

## Operation and Maintenance

Installation should be in accordance with local plumbing codes. Flush all pipes thoroughly before installation. After installation, remove spout outlet or flow control and flush faucet thoroughly to clear any debris. Care should be taken when cleaning the product. Do not use abrasive cleaners, chemicals or solvents as they can result in surface damage. Use mild soap and warm water for cleaning and protecting the life of Chicago Faucet products. For specific operation and maintenance refer to the installation instructions and repair parts documents that are located at [www.chicagofaucets.com](http://www.chicagofaucets.com).

Chicago Faucets, member of the Geberit Group, is the leading brand of commercial faucets and fittings in the United States, offering a complete range of products for schools, laboratories, hospitals, office buildings, food service, airports and sport facilities. Call 1.800.TECTRUE or 1.847.803.5000 Option 1 for installation or other technical assistance.

