

Accessories & Parts

892-CP

Product Type



Atmospheric vacuum breaker

Features & Specifications

- Atmospheric vacuum breaker, not intended for continuous pressure applications
- 1/2" NPT female thread inlet
- 1/2" NPT female thread outlet

Warranty

Codes & Standards

-  ASSE 1001 Certified
-  ASME A112.18.1/CSA B125.1

Job Name _____

Item Number _____

Section/Tag _____

Model Specified _____

Architect _____

Engineer _____

Contractor _____

Submitted as Shown Submitted with Variations

Date _____

*No
Image
Available*

Architect/Engineer Specification

Chicago Faucets No. 892-CP, Atmospheric Vacuum Breaker, chrome plated. Atmospheric vacuum breaker, not intended for continuous pressure applications.

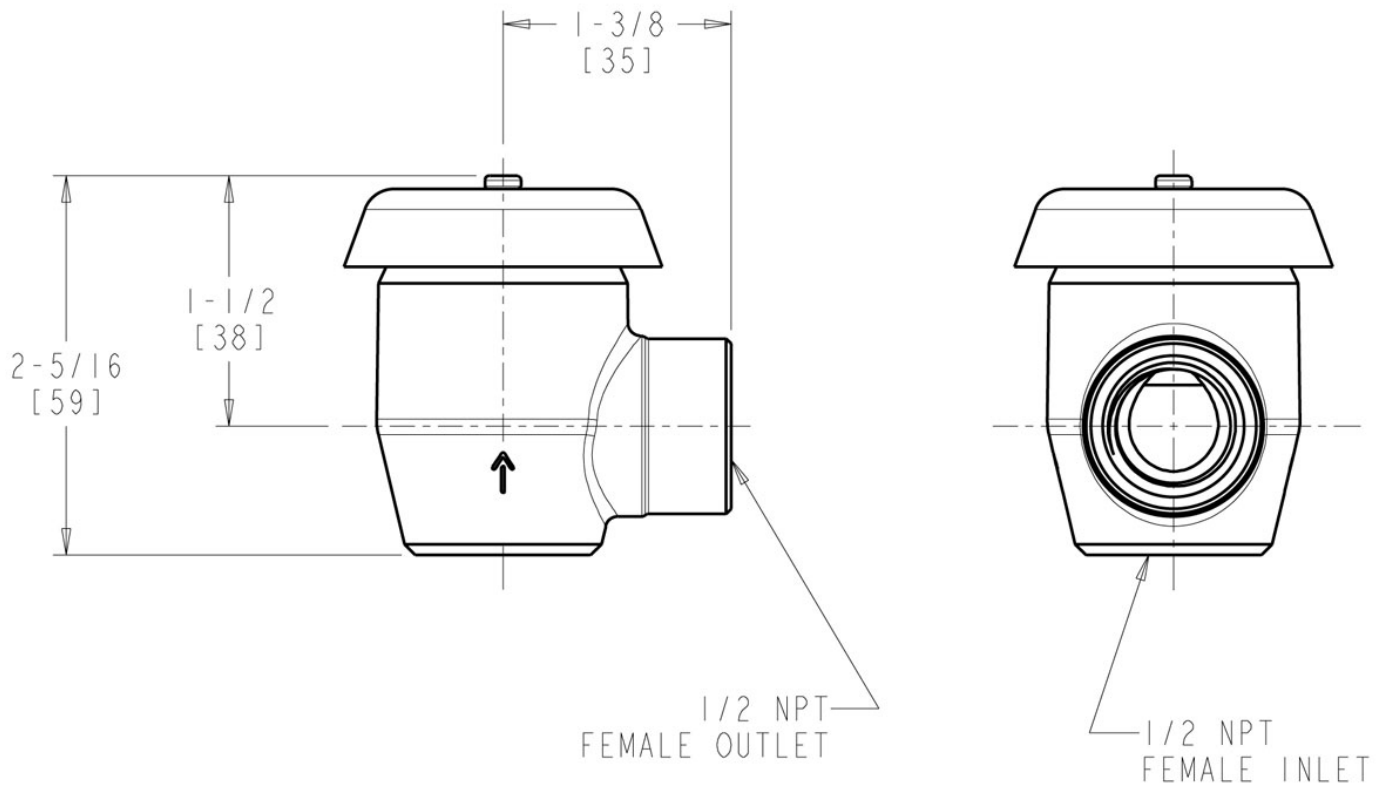

Operation and Maintenance

Installation should be in accordance with local plumbing codes. Flush all pipes thoroughly before installation. After installation, remove spout outlet or flow control and flush faucet thoroughly to clear any debris. Care should be taken when cleaning the product. Do not use abrasive cleaners, chemicals or solvents as they can result in surface damage. Use mild soap and warm water for cleaning and protecting the life of Chicago Faucet products. For specific operation and maintenance refer to the installation instructions and repair parts documents that are located at www.chicagofaucets.com.

Chicago Faucets, member of the Geberit Group, is the leading brand of commercial faucets and fittings in the United States, offering a complete range of products for schools, laboratories, hospitals, office buildings, food service, airports and sport facilities. Call 1.800.TECTRUE or 1.847.803.5000 Option 1 for installation or other technical assistance.

