

CHICAGO FAUCETS
a Geberit company

2100 South Clearwater Drive
Des Plaines, IL 60018
Phone: 847-803-5000
Fax: 847-803-5454
www.chicagofaucets.com

REPAIR PARTS

FITTING NO.

349-L8CP

SUBMITTED MODEL NO.

ITEM NO.

BY: SID DATE: 08-28-09

CHK: *[Signature]* REV:

FOR TECHNICAL ASSISTANCE
1-800-TEC-TRUE (1-800-832-8783)

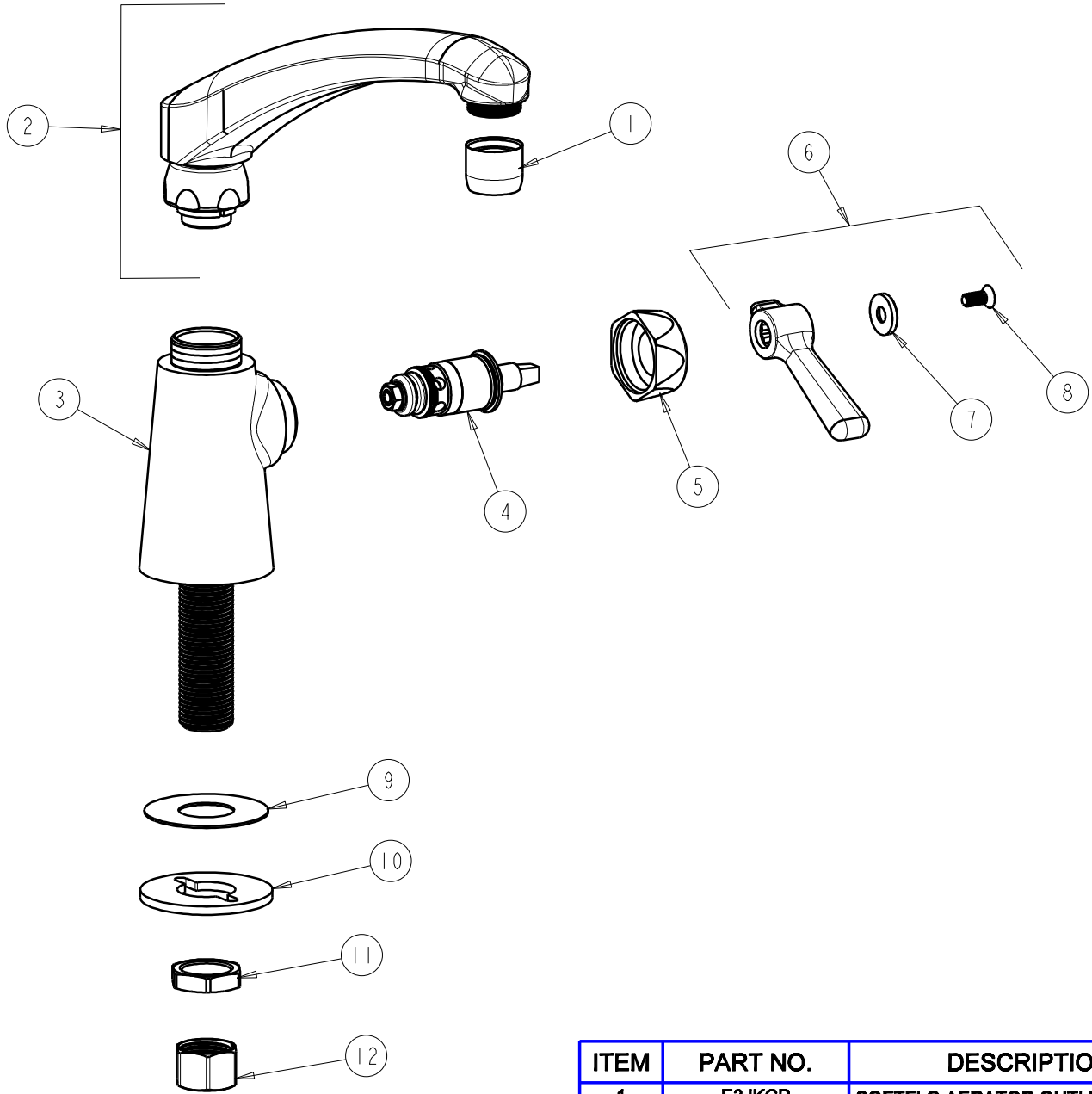

ITEM	PART NO.	DESCRIPTION
1	E3JKCP	SOFTFLO AERATOR OUTLET
2	L8JKCP	FOR PARTS SEE L8JKCP
3	—	BODY VALVE (NOT SOLD SEPARATELY)
4	1-099XTJKNF	QUATURN UNIT (RH)
5	444-005JKCP	CAP
6	369-COLDJKCP	LEVER HANDLE ASSEMBLY
7	633-123JKNF	INDEX BUTTON (BLUE)
8	420-010JKRCF	SCREW, 10-32 UNC PH 1/2
9	52-007JKNF	WASHER, RUBBER
10	807-112JKNF	WASHER
11	49-004JKRBF	LOCKNUT
12	49-005JKRBF	COUPLING NUT