

CHICAGO FAUCETS
a Geberit company

2100 South Clearwater Drive
Des Plaines, IL 60018
Phone: 847-803-5000
Fax: 847-803-5454
www.chicagofaucets.com

REPAIR PARTS

FITTING NO.

201-AGN2AE3-317XKCP

SUBMITTED MODEL NO.

BY: SID

DATE: 06-18-09

CHK:

REV: 04-23-12

ITEM NO.

FOR TECHNICAL ASSISTANCE
1-800-TEC-TRUE (1-800-832-8783)

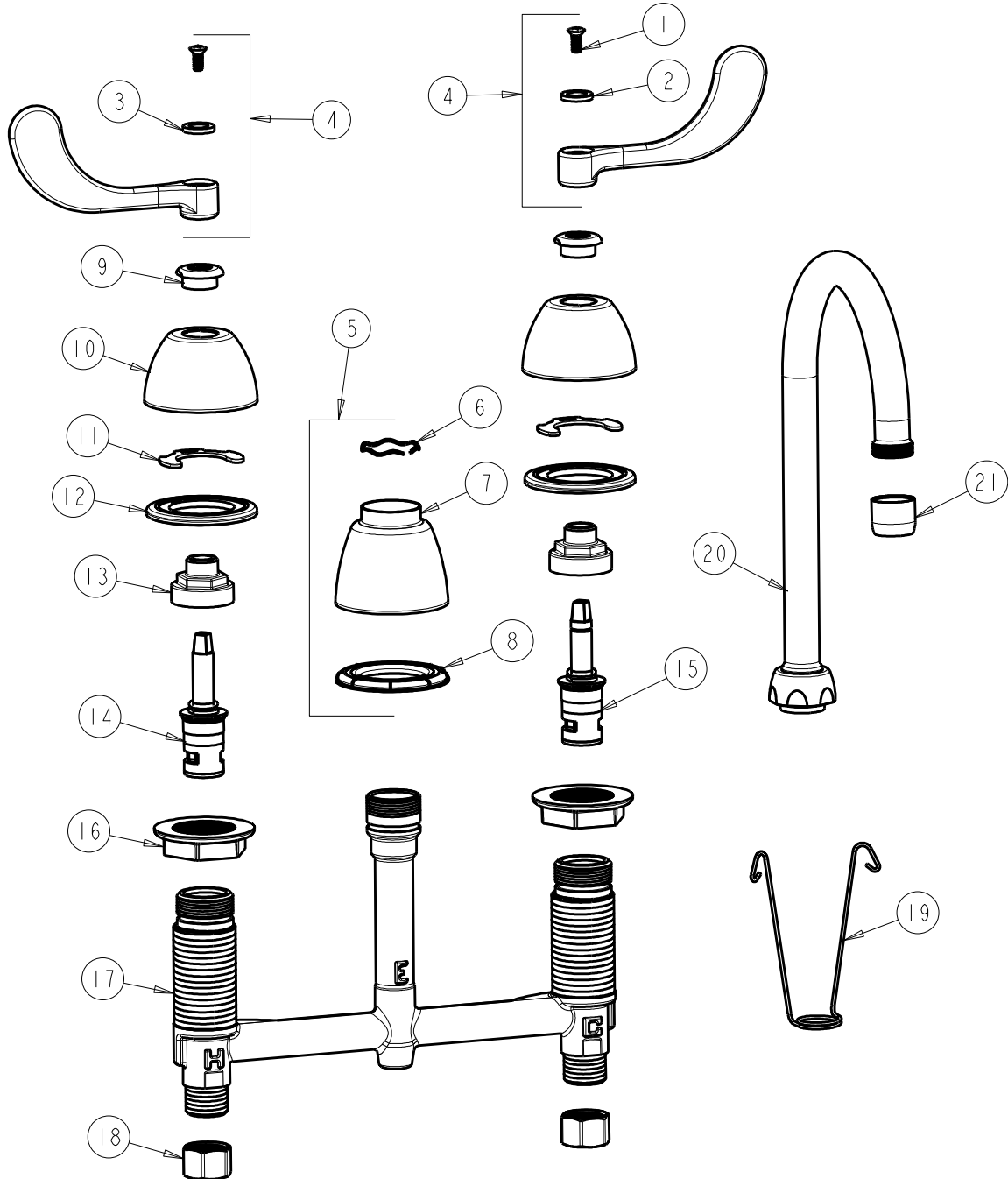

ITEM	PART NO.	DESCRIPTION	ITEM	PART NO.	DESCRIPTION
1	420-010JKRCF	SCREW, 10-32 UNC PH 1/2	12	888-026JKNF	WASHER, SEALING
2	633-123JKNF	INDEX BUTTON (BLUE)	13	274-014JKRBF	NUT, CAP
3	633-023JKNF	INDEX BUTTON (RED)	14	377-XKLHJKNF	LH CERAMIC CARTRIDGE 1/4
4	317-PRJKCP	HANDLE, 4" WRISTBLADE (PAIR)	15	377-XKRHJKNF	RH CERAMIC CARTRIDGE 1/4
5	785-400JKCP	SPOUT ESCUTCHEON KIT	16	250-004JKNF	LOCKNUT
6	50-038JKNF	WAVE WASHER	17	—	BODY, VALVE
7	785-400JKCP	ESCUTCHEON, SPOUT BASE	18	49-005JKRBF	COUPLING NUT
8	888-027JKNF	SPOUT ESCUTCHEON WASHER	19	200-008JKNF	HANGER
9	422-113JKCP	ESCUTCHEON NUT	20	GN2AJKCP	SPOUT
10	250-082JKCP	ESCUTCHEON	21	E3JKCP	SOFTFLO AERATOR 2.2 GPM
11	200-009JKNF	CLIP, RETAIN			