

Widespread Fittings Installation Instructions

Recommended for base numbers: 200, 201, 404, 405, 786, all "HZ" models, all "PO" models

Overview

Chicago Faucets deck mounted faucets feature cast brass bodies and precision cartridges for years of reliable operation. Metering models with adjustable cycle time offer true water savings.

Notice to the Installer

- Read this entire instruction sheet before installing to ensure proper installation.
- Installation must comply with local codes and ordinances.

Pressurized plumbing fixtures shall be installed in accordance with manufacturer's recommendations. The supply piping to these devices shall be securely anchored to the building structure to prevent installed device from unnecessary movement when operated by the user. Care shall be exercised when installing the device to prevent marring the exposed surface.

NOTE: The information in this manual is subject to change without notice.

Please leave this manual with the facility manager after completing the faucet installation. This document contains information necessary for routine maintenance and servicing.

NOTE: Before installation, turn off water supplies to existing faucet and remove faucet if replacing. Clean faucet basin and clear away debris. Flush all supply lines before connecting to faucet. Failure to do so can result in debris clogging the inlets and/or cartridges.

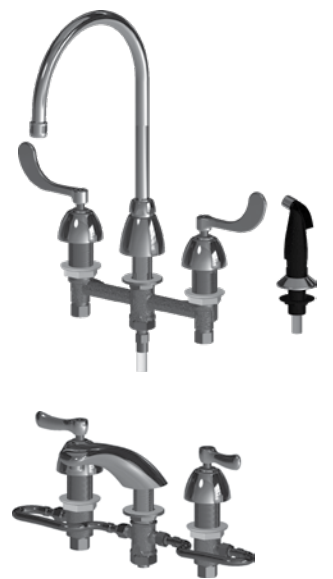

Exploded Views:

Tall Stem Cartridge

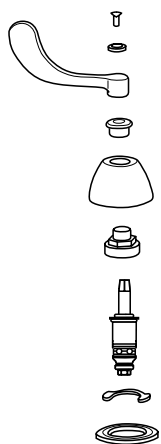

Short Stem Cartridge



Metering



"HZ" Models with Flexible Supply Hoses

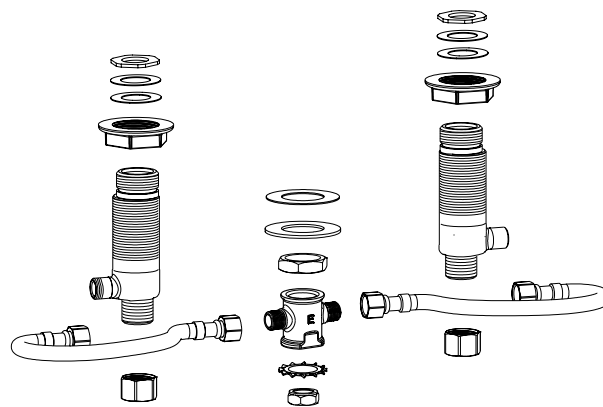

Waste Fitting

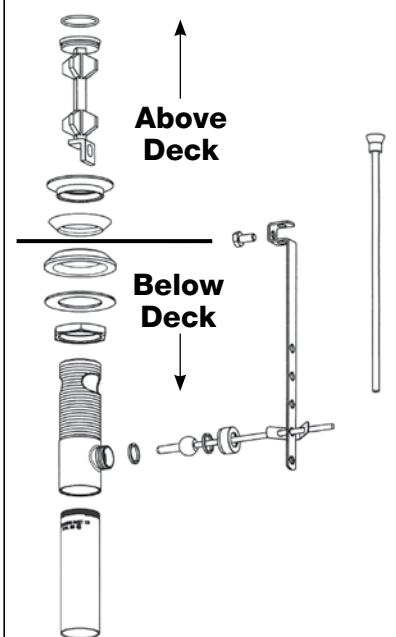

Other Configurations:

200 Series

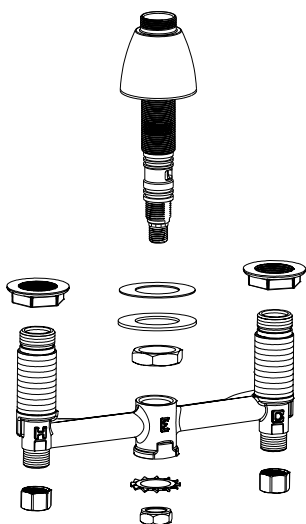

404 Series

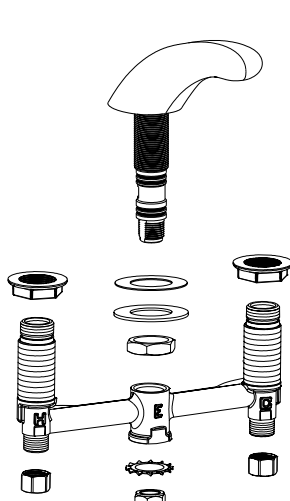

405 Series

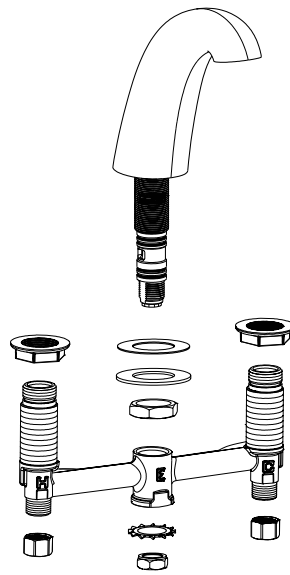
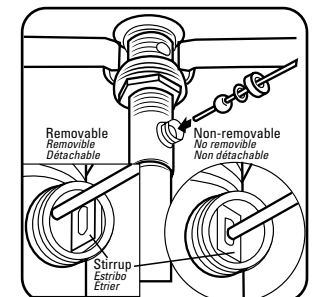
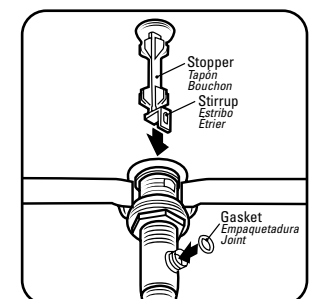
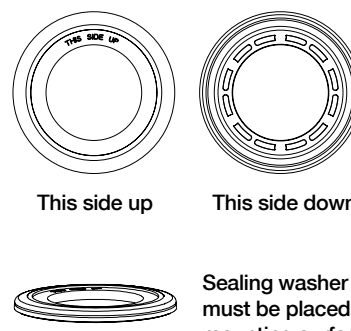
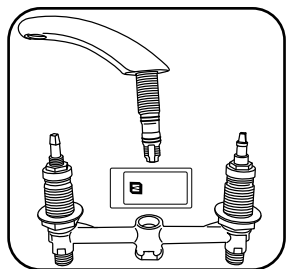

ILLUSTRATION A



One-Piece Body Installation



1. Using grease from supplied packet, lubricate the 4 o-rings on the spout shank and inside of center hub of undermount body.

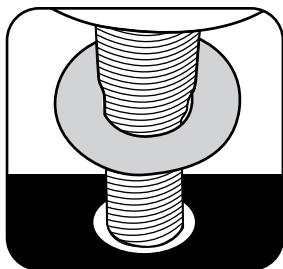

2. Slide the shank through the slim rubber washer and top center hole of deck.

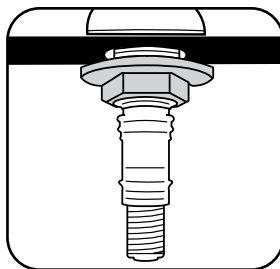

3. From below deck, use nut and metal washer to secure spout to deck. Hand tighten.

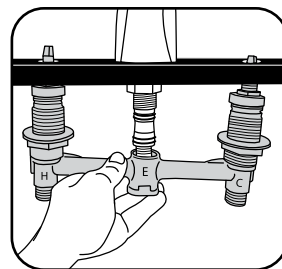

4. Align the undermount body (marked H & C for connections) with deck holes and shank. Push the center of the undermount body (E) onto shank. Be careful not to pinch o-rings.

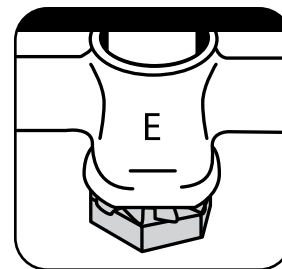

5. Install lockwasher and nut to the shank. Hand tighten.

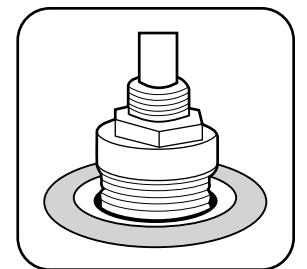

6. Above deck, place a sealing washer over each handle stem and around the cartridge housing.

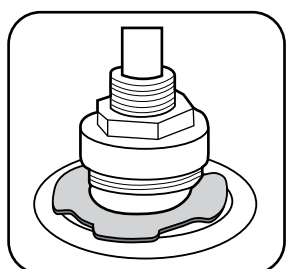

7. Slide a retaining clip on top of the sealing washer and into the groove of each cartridge housing.

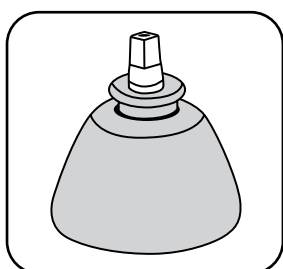

8. Install and tighten escutcheons over each handle.

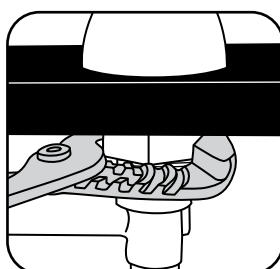

9. Below deck, hand tighten the flanged nuts and then with a wrench tighten 1/4 - 1/2 turn more.

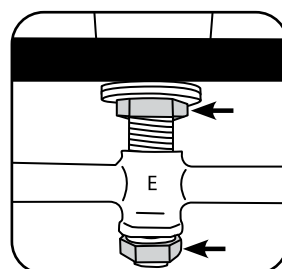

10. With a wrench, tighten center lower nut on shank and upper center nut.

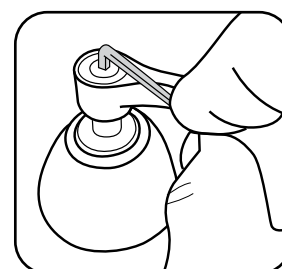

11. Install handles, connect water lines, and flush lines.

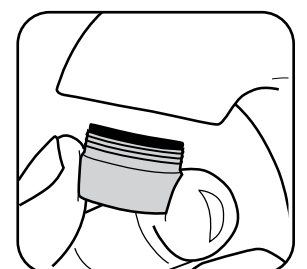

12. Install aerator and flush again.

Widespread Fittings Installation Instructions

(continued)

Spout Installation

Swing Spout

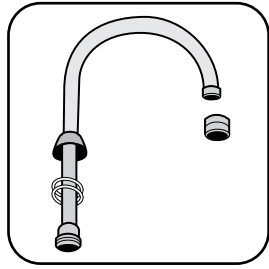

1. Remove outlet from spout. Place two split rings on spout near the base. Slide spout nut onto spout.



2. Place spout onto valve body until fully seated. Tighten spout nut with wrench. Connect water supplies, flush line, and attach outlet.

Rigid Spout

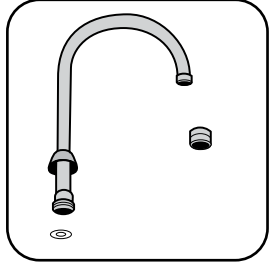

1. Remove outlet from spout. Slide spout nut onto spout. Place solid white washer into base outlet.

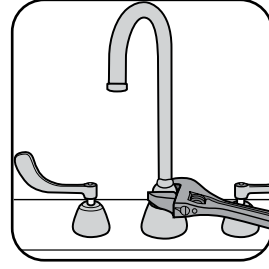

2. Place spout onto valve body until fully seated. Tighten spout nut with wrench. Connect water supplies, flush line, and attach outlet.

Restricted Swing Spout

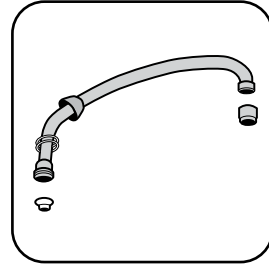

1. Remove outlet from spout. Place two split rings on spout tubing near base. Slide spout nut onto spout.

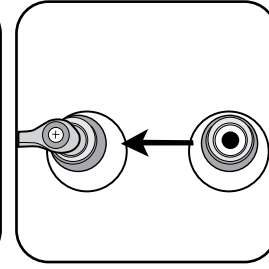

2. Place restricted swing adaptor into valve body and align with internal valve body tab. Position small opening (70°) or large opening (120°) toward "hot" side of body.

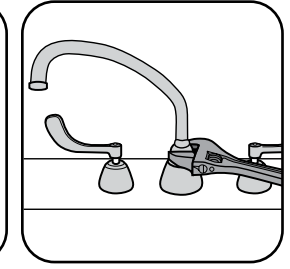

3. Place spout into stem. Tighten spout nut with wrench. Connect water supplies, flush line, and attach outlet.

Fully Adjustable Body Installation

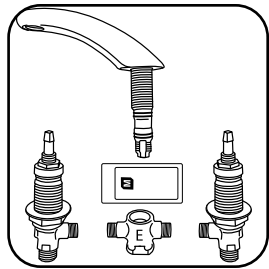

1. Using grease from supplied packet, lubricate the 4 o-rings on the spout shank and inside of center hub of undermount body.

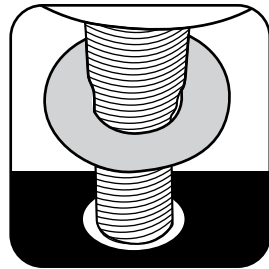

2. Slide the shank through the slim rubber washer and top center hole of deck.

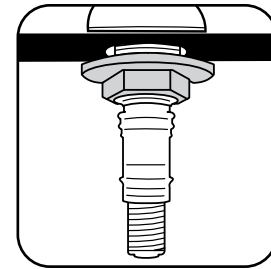

3. From below deck, use nut and metal washer to secure spout to deck. Hand tighten.

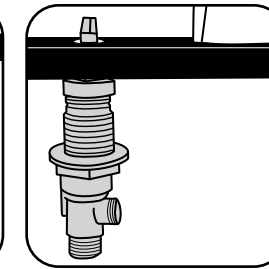

4. From below deck, align handles with deck holes. Push through deck hole and repeat with other side.

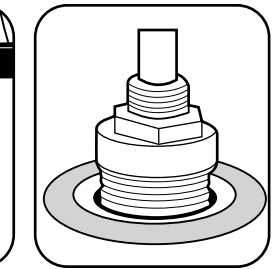

5. Above deck, place a sealing washer over each handle stem and around the cartridge housing.

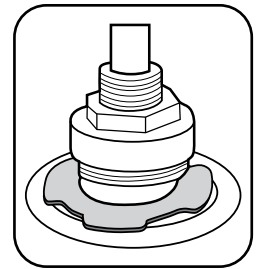

6. Slide a retaining clip on top of the sealing washer and into the groove of each cartridge housing.

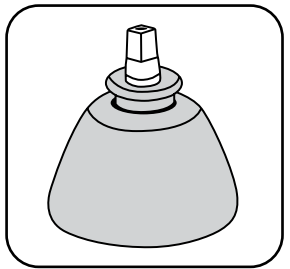

7. Install and tighten escutcheons over each handle.

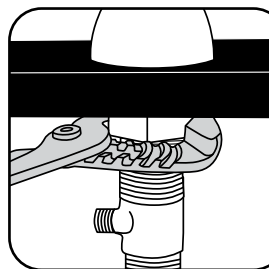

8. Below deck, hand tighten the flanged nuts and then with a wrench tighten 1/4 - 1/2 turn more.

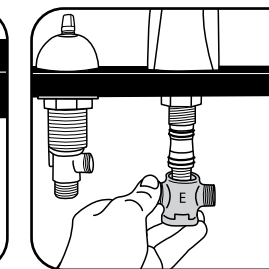

9. Align the undermount body (E) with deck holes and shank. Push the center of the undermount body onto shank. Be careful not to pinch o-rings.

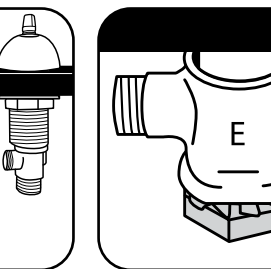

10. Install lockwasher and nut to the shank. Hand tighten.

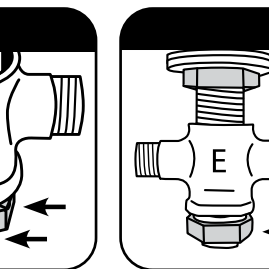

11. With a wrench, tighten center lower nut on shank and upper center nut.

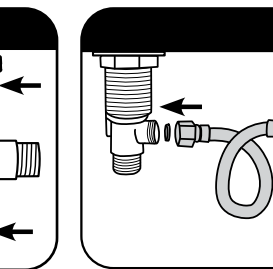

12. Connect left supply line to left handle and left side of water connector. Repeat with right supply line.

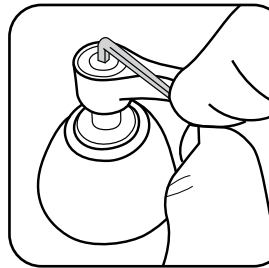

13. Install handles, connect water lines, and flush lines.

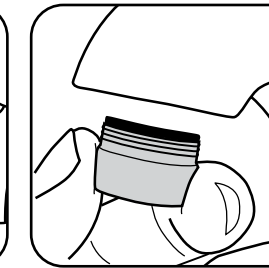

14. Install aerator and flush again.

Timing Adjustment on an MVP Metering Cartridge

1. With cartridge and handle installed in body and water supply turned on, purge cartridge of air by pushing handle completely down 4-8 times repeatedly, then check timing cycle.
2. To change cycle time, remove index button and screw from the handle. (Figure A)
3. Using your fingers change height of adjustment nut by 1/4 turn only. Turn adjustment nut clockwise to increase cycle time or counter-clockwise to decrease cycle time. (Figure B)
4. Replace handle and verify desired cycle time.
NOTE: TIMING MUST BE CHECKED WITH HANDLE IN PLACE.
5. If additional adjustment is necessary, repeat steps 3 and 4 until desired cycle time is achieved.
6. Attach handle and tighten screw. Insert index button to cover handle screw.
NOTE: Some new installations might produce a slight closing noise. This is normally the result of air trapped in the cartridge and noise will dissipate over time.

MVP Metering Cartridges

1. If filter and lower valve cartridge have been removed from fitting, replace them by inserting filter first.
2. If gasket has been removed from the actuator assembly, replace it by inserting into bottom of actuator assembly.
3. Assemble actuator assembly to body and tighten to 12-15 FT. LBS. torque.
4. Assemble handle and check timing, adjust if necessary.
5. Tighten screw to secure the handle.
6. Insert index button into top of the handle.

FIGURE A

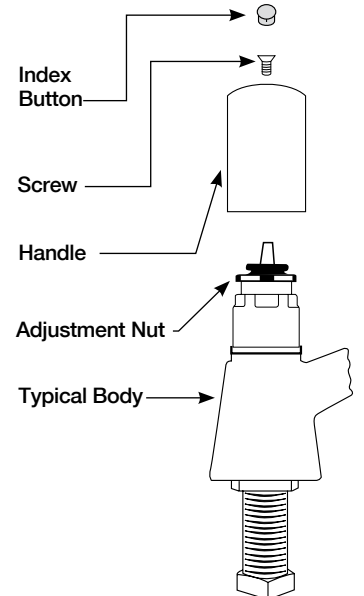
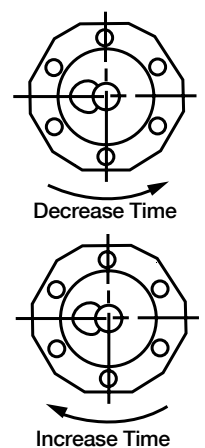

FIGURE B

How To Adjust (Top View)



Care and Maintenance

All Chicago Faucets fittings are designed and engineered to meet or exceed industry performance standards. Care should be taken when cleaning this product. Do not use abrasive cleaners, chemicals or solvents as they can result in surface damage. Use mild soap with warm water for cleaning and protecting the surface of Chicago Faucets fittings.

For additional technical assistance, call 800/TEC-TRUE (800-832-8783) or visit our website at chicagofaucets.com.

CHICAGO FAUCETS LIMITED WARRANTY

TO WHOM DOES THIS WARRANTY APPLY? — The Company extends the following limited warranty to the original user only.
WHAT DOES THIS WARRANTY COVER AND HOW LONG DOES IT LAST?

This warranty covers the following Commercial Products:

LIFETIME FAUCET WARRANTY — The "Faucet," defined as any metal cast, forged, stamped or formed portion of the Product, not including electronic or moving parts or other products separately covered by this Limited Warranty or water restricting components or other components, is warranted against material manufacturing defects for the life of the Product.

FIVE YEAR FAUCET WARRANTY — Certain Products and portions of the Product are warranted against material manufacturing defects for a period of five (5) years from the date of Product purchase. Products warranted against material manufacturing defects for a period of five (5) years from the date of Product purchase are referred to by the product numbers 42X, 43X, 15XX and E-Tronic® - 4X, 5X, 6X, 7X, 8X and 9X. All zinc die cast portions of Product are warranted against material manufacturing defects for a period of five (5) years from the date of Product purchase.

THREE YEAR ELECTRONICS WARRANTY — Electronic components, including the solenoid, are warranted for three (3) years from the date of installation.

FIVE YEAR CARTRIDGE WARRANTY — The "Cartridge," defined as the metal portion of any Product typically referred to by the product numbers containing 1-099, 1-100, 1-310, 377X, 217X and 274X, excluding any rubber or plastic components, is warranted against material manufacturing defects for a period of five (5) years from the date of Product purchase. All Cartridges included in the Company's Single Control or Shower Products also are warranted against material manufacturing defects for a period of five (5) years from the date of Product purchase.

ONE YEAR FINISH WARRANTY - COMMERCIAL — For Products used in commercial applications, the finish of the Product is warranted against material manufacturing defects for a period of one (1) year from the date of Product purchase.

OTHER WARRANTIES — All other Products not covered above are warranted against material manufacturing defects for a period of one (1) year from the date of Product purchase.

Other restrictions and limitations apply. For complete warranty details, call Chicago Faucets Customer Service at 847-803-5000 or visit chicagofaucets.com.

The Chicago Faucet Company
2100 South Clearwater Drive
Des Plaines, IL 60018
Phone: 847/803-5000
Fax: 847/803-5454
Technical: 800/832-8783
www.chicagofaucets.com